

HENRY

Hydraulic Engineering Repository

Ein Service der Bundesanstalt für Wasserbau

Conference Paper, Published Version

Jeong, Sangseom; Won, Jin-Oh; Suh, Jungju

Analysis of Pile Groups Cinsidering Riverbed Scouring

Verfügbar unter/Available at: <https://hdl.handle.net/20.500.11970/100387>

Vorgeschlagene Zitierweise/Suggested citation:

Jeong, Sangseom; Won, Jin-Oh; Suh, Jungju (2002): Analysis of Pile Groups Cinsidering Riverbed Scouring. In: Chen, Hamn-Ching; Briaud, Jean-Louis (Hg.): First International Conference on Scour of Foundations. November 17-20, 2002, College Station, USA. College Station, Texas: Texas Transportation Inst., Publications Dept.. S. 854-868.

Standardnutzungsbedingungen/Terms of Use:

Die Dokumente in HENRY stehen unter der Creative Commons Lizenz CC BY 4.0, sofern keine abweichenden Nutzungsbedingungen getroffen wurden. Damit ist sowohl die kommerzielle Nutzung als auch das Teilen, die Weiterbearbeitung und Speicherung erlaubt. Das Verwenden und das Bearbeiten stehen unter der Bedingung der Namensnennung. Im Einzelfall kann eine restriktivere Lizenz gelten; dann gelten abweichend von den obigen Nutzungsbedingungen die in der dort genannten Lizenz gewährten Nutzungsrechte.

Documents in HENRY are made available under the Creative Commons License CC BY 4.0, if no other license is applicable. Under CC BY 4.0 commercial use and sharing, remixing, transforming, and building upon the material of the work is permitted. In some cases a different, more restrictive license may apply; if applicable the terms of the restrictive license will be binding.



Analysis of Pile Groups Considering Riverbed Scouring

By

Sangseom Jeong¹, Jinhon Won², Jungju Suh²

¹Associate Professor, Dept. of Civil Engineering, Yonsei University, 134 Shinchon-dong, Seodaemun-gu, Seoul, 120-749, Korea. (soj9081@yonsei.ac.kr)

²Ph.D. student, Dept. of Civil Engineering, Yonsei University, 134 Shinchon-dong, Seodaemun-gu, Seoul, 120-749, Korea. (wjo20@yonsei.ac.kr) , (winaler@yonsei.ac.kr)

ABSTRACT

This paper describes a simplified numerical procedure for analyzing the response of bridge pier foundations due to riverbed scouring. A computationally efficient algorithm to analyze the behavior of a pile group is proposed by considering soil-pile, pile-cap, and pile-fluid interactions. The complex phenomenon of the pile-soil interaction is modeled by discrete nonlinear soil springs (p-y, t-z and q-z curves). The pile-cap interaction is considered by geometric configuration of the piles in a group and connectivity conditions between piles and the cap. The pile-fluid interaction is incorporated into the procedure by reducing the stiffness of the soil-pile reactions as a result of nonlinearity and degradation of the soil stiffness with river bridge scouring. Through the numerical study, it is shown that the maximum bending moment is increased with increasing scour depth. Thus it is desirable to check the stability of pile groups based on soil-pile and pile-cap interactions by considering scouring depth in the riverbed.

INTRODUCTION

Pile groups are the most common type used for bridge foundations because they can transfer applied axial and lateral loads on superstructure to bearing ground efficiently and safely. Pile group foundation consists of several single piles and one pile cap. Total bearing capacity of a pile group is the sum of each bearing capacity of single piles and that of a pile cap which is in direct contact with the soil.

A pile group is not collapsed immediately under sudden attack of flood flows which cause scouring along the pile, because bearing capacity that comes from the interaction between individual pile in a group and a pile cap resists scouring. Therefore, the analysis by considering the scour depth of bridge foundation is required to evaluate the stability of a pile group under applied load.

In this study, a three-dimensional analysis of pile groups is performed by considering soil-pile, pile-cap interactions based on riverbed scouring. The complex phenomenon of the soil-pile interaction is modeled by discrete nonlinear soil springs (p - y , t - z , and q - z curves) and the effect of riverbed scouring is considered by elimination or degradation of the soil stiffness. The pile-cap interaction is analyzed by stiffness method which can be considered by geometric configuration of the piles in a group and connectivity conditions between piles and a cap. Through the three-dimensional analysis program (YS-3DPILE) of pile groups developed in this study, the displacement and rotation of a cap and member forces of individual pile in a group such as bending moment and shear force were estimated with varying scour depth of riverbed.

METHOD OF ANALYSIS CONSIDERING BRIDGE SCOUR

If the scour depth affects below the pile cap, pile groups are not failed at once but has some hazardous effects. For example, excessive horizontal displacement of a pile cap resulting from riverbed scouring may lead to structural damage (Fig. 1). Analysis only based on the estimated scour depth is not sufficient to consider the failure mode of pile groups caused by scouring under flood. So, it is a three-dimensional pile group analysis method that is recommended to think over the effect of scouring and the interaction between each one of piles and a pile cap.

The analytical method considering pile-cap interaction was firstly suggested by Hrennikoff (1949) using the stiffness method. Reese (1970) developed a 3D analytical method of pile groups, using the modified Hrennikoff's method. This method was extended to incorporate the pile-soil-pile interaction by O'Neill et al. (1977) and Chow et al. (1986). In this study, a similar approach suggested by O'Neill et al. (1977) is used and implemented as

(1) Calculation of a pile head stiffness of each pile in a group

: Calculate a pile head stiffness of an individual pile on each loading step in different cases such as different pile properties (embedded length, diameter, and elastic modulus) and different soil layer properties (scour depth, depths of each soil layer and its properties).

(2) Pile-cap analysis considering individual pile head stiffness (k_{ij})

: Using all the individual pile head stiffnesses that are initially estimated in the first loading step, formulate the full stiffness matrix. Calculate pile cap displacement and individual pile head forces (P_{ix} , P_{iy} , P_{iz}) and moments (M_{iz} , M_{iy} , and M_{ix}) for all the piles in the group.

(3) Iteration to convergence

: Compare the computed individual pile head forces and moments with the applied distributed load components used in step (2) for all the individual piles if the difference between them meets the user-specified closure tolerance level. If the convergence criterion is not satisfied, using the new computed pile head forces and moments, calculate a new individual pile head stiffness matrix for each pile again and repeat this iteration process. If it is satisfied, go to next step.

(4) Evaluate response of all individual piles

: Finally, evaluate responses of all the individual piles in a group, using the final individual pile head forces and moments.

The flowchart that shows all the steps described above is also given in Fig. 2. Based on the proposed algorithm, a new computer program YS-3DPILE has been developed to analyze the behavior pile groups by considering both soil-pile and pile-cap interactions. (Jeong, 1999)

LOAD TRANSFER CURVES

For axially loaded piles, the load-transfer curves were modeled by t-z and q-z curves. The type of t-z and q-z curves supported by the program is a linear elastic-plastic curve as shown in Fig. 3. According to soil types such as soil and rock, a maximum unit skin friction, t_{\max} was estimated as follows:

In the soil, t_{\max} was estimated by β method (Burland, 1973):

$$t_{\max} = \beta \sigma'_z \quad (1)$$

where, β is approximately 0.3 and t_{\max} is linearly increased to a critical depth (15D, D : diameter), beyond which it remains as a constant to failure.

For the rock, t_{\max} was estimated using the method proposed by Reese and O'Neill (1987):

$$t_{\max} = 0.15q_u \quad (2)$$

where, q_u is the unconfined shear strength, and limited to 100kN/m² (weathered rock), 150kN/m² (soft rock), and 200kN/m² (hard rock).

In Fig. 3, z_c is a critical displacement of the pile segment at which t_{\max} is mobilized. Vijayvergiya recommended 0.2 to 0.3inch for z_c , so in this study 0.2inch (0.5mm) of z_c is adopted.

For laterally loaded piles, the load-transfer curves were modeled by p-y curves. A hyperbolic function was used to describe the relationship of the p-y curve (Fig. 4) which has an ultimate resistance (p_u) and an initial tangent stiffness (E_s). The initial tangent stiffness used in this study was assumed to vary linearly with depth as recommended by Reese et al. (1974).

To analyze the change of group pile behavior, especially in the presence of bridge scouring, load transfer curves (p-y, t-z, and q-z curves) within the scour depth are assumed to be eliminated, beyond which they are reconstructed along the embedded pile length by reducing the ultimate resistance (p_u).

ANALYSIS AND RESULTS

To examine the pile group behavior with riverbed scouring, a series of idealized cases were examined based on the major influencing parameters such as cap rigidity and the spacing between piles. Fig. 5 shows a group pile configuration to be analyzed considering scouring. The material properties for pile groups are shown in table 1. Four piles, arranged by 2 rows and 2 columns and fixed and hinged head conditions are considered between piles and a pile cap. The piles are made of pre-cast concrete and the elastic modulus is $4,000,000 \text{ kN/m}^2$. Each pile is 0.5 m in diameter and 10 m in embedded length. The soil is uniform sand and the friction angle, the cohesion, and the unit weight are 30 degree, 0 kN/m^2 , and 17.0 kN/m^3 , respectively. The applied axial and lateral loads are 200 kN and 100 kN, respectively. The scour depth (H_s) is increased from 0 to 5 m by increment of 1 m. In each scour depth a three-dimensional analysis was performed.

(1) Effect of Cap Rigidity

Fig. 6 and 7 show the displacement and rotation of a cap with varying scour depths in both fixed and hinged pile head conditions. As shown in these figures, the displacement of the pile cap is increased as the scour depth increases and the magnitude is seem to be significantly larger for the hinged head case than for the fixed head case. The rotation of a pile cap for the fixed head case is also increased with increasing the scour, but its absolute value is not significant. For the hinged head case the rotation of a pile cap is always seem to be zero.

Fig. 8, 9, and 10 show lateral pile displacement, bending moment, and shear force profiles along the embedded pile length of no. ① pile as shown in Fig. 5. Fig. 8 shows that the lateral displacement of pile is increased as the scour depth increases. The distribution of bending moment along the pile and its change with scouring are represented in Fig. 9. For the fixed head case, the maximum bending moment is occurred at the pile head. When scour depth is increased from 0 to 5m, the maximum bending moment at the pile head is increased approximately up to 340%. For the hinged head, the position where the maximum bending moment occurs moves down and its magnitude

increases approximately up to 600% as the scour depth is increased. Fig. 10 is the distribution of shear forces along the pile. For the fixed head case the shear force has a maximum value at the scoured bed level, but for the hinged head case it has a maximum value below the scoured bed level and the magnitude is also increased as the scour depth increases.

(2) Effect of Spacing (s/d)

In the analysis, the pile groups with different pile center-to-center spacing were assumed to have the same initial scour depth. Pile spacings (s/d) selected in this study were 2.0, 4.0, and 8.0. Scour depth used changes from 0 to 5m. Fig. 11 and 12 show the effect of pile spacing with varying scour depths on the lateral displacement and rotation of pile cap. The lateral displacement and rotation of pile cap increase as scour depth is increased. On the other hand, the effect of s/d was more sensitive to the rotation than to the lateral displacement.

Fig 13 shows the magnitude of maximum bending moment as a function of the pile spacing and scour depth. The maximum bending moment developed at the pile head and varies linearly as scour depth increased. However, for the three spacings studied, there is little difference in maximum bending moment.

(3) Difference in Bearing Capacity

The variation of ultimate bearing capacity of vertically loaded pile groups due to riverbed scouring was examined. The ultimate pile capacity was calculated by using the proposed method of US Army Corps of Engineers (1991). Table 2 shows the variation of bearing capacity of pile groups with varying scour depths. The skin friction of single pile is significantly decreased as scour depth is increased, whereas endbearing resistance remains constant because the pile point was located below the critical depth. The ultimate bearing capacity of pile groups, calculated by multiplying number of piles with each single pile capacity, is decreased to about 57% as scour depth is increased from 0 to 5m.

CONCLUSIONS

In this study, a computationally efficient algorithm to analyze a group pile behavior is proposed in consideration of soil-pile, pile-cap, and pile-fluid interactions. A limited parametric study of the response of pile groups was performed to examine the scouring effect. The following conclusions are drawn from the present study:

1. Under the same loading applied before and after scouring, the displacement along the pile length is increased with increasing scour depth.

2. The maximum bending moment along the pile increases as the scour depth increases. This is particularly more significant for hinged head condition than for fixed head condition.
3. The pile spacing effect is significant for the rotation of pile. However the lateral pile cap deflection and maximum bending moment are more influenced by scour depth than pile spacing.
4. To check the stability of bridge piers in the riverbed, it is recommended to perform a group pile analysis considering soil-pile and pile-cap interactions based on scouring effect.

ACKNOWLEDGEMENTS

This paper was supported by grant No. 1999-1-311-02-3 from the interdisciplinary Research program of the KOSEF in Korea.

REFERENCES

1. Burland, J. B. 1973, "Shaft friction Piles in Clay – A Simple Fundamental Approach." *Ground Engineering*, Vol. 6, No. 3, pp.30-42.
2. Chow, Y. K. 1987, "Three-dimensional analysis of pile groups." *Journal of Geotechnical Engineering*, Vol. 113, No. 6, pp637-651, ASCE, USA.
3. Hrennikoff, A. 1949, "Analysis of pile foundation with batter piles." *Trans.*, Vol. 79, pp351-374, ASCE, USA.
4. Jeong, S. S., Chung, S. H., and Won, J. O. 2001, "Analysis of group pile-cap interaction by load transfer approach." *Journal of the Korean Geotechnical Society*, Vol. 17, No. 3, pp95-102, Korea.
5. O'Neill, M. W., Ghazzaly, O. I., and Ha, H. B. 1977, "Analysis of three-dimensional pile groups with nonlinear soil response and pile-soil-pile interaction." *Proc. 9th Offshore Technology Conf. 2*, pp245-256.
6. Reese, L. C., O'Neill, M. W., and Smith, R. E. 1970, "Generalized analysis of pile foundation." *Journal of Soil Mech. Found. Div.*, Vol. 96, No. 1, pp235-250, ASCE, USA.

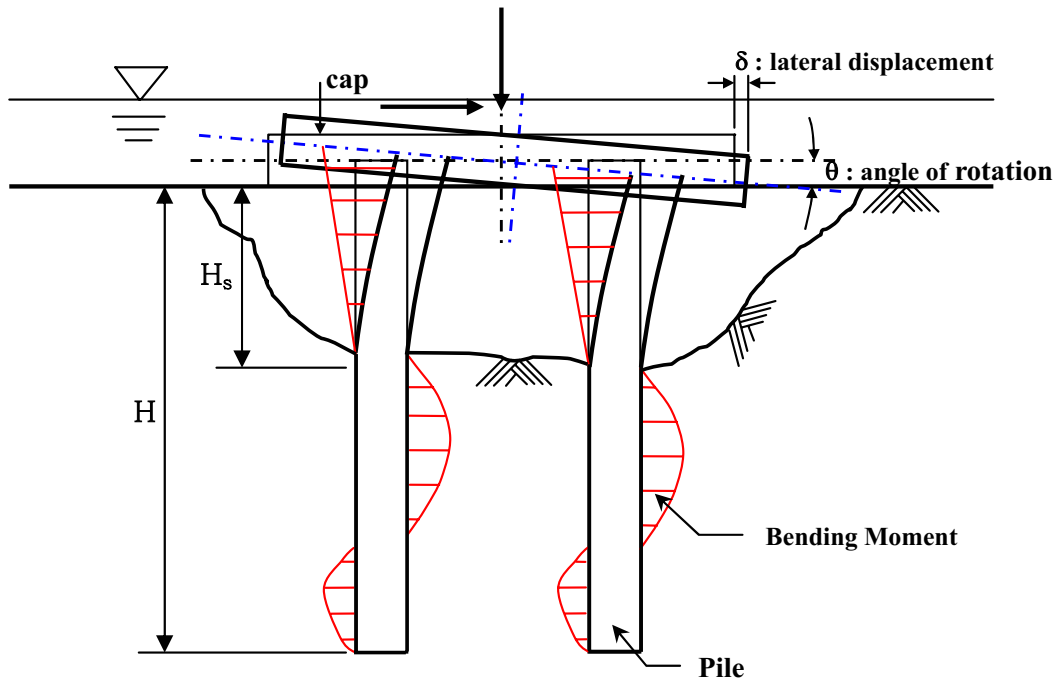

Fig. 1 – Pile groups with riverbed scouring

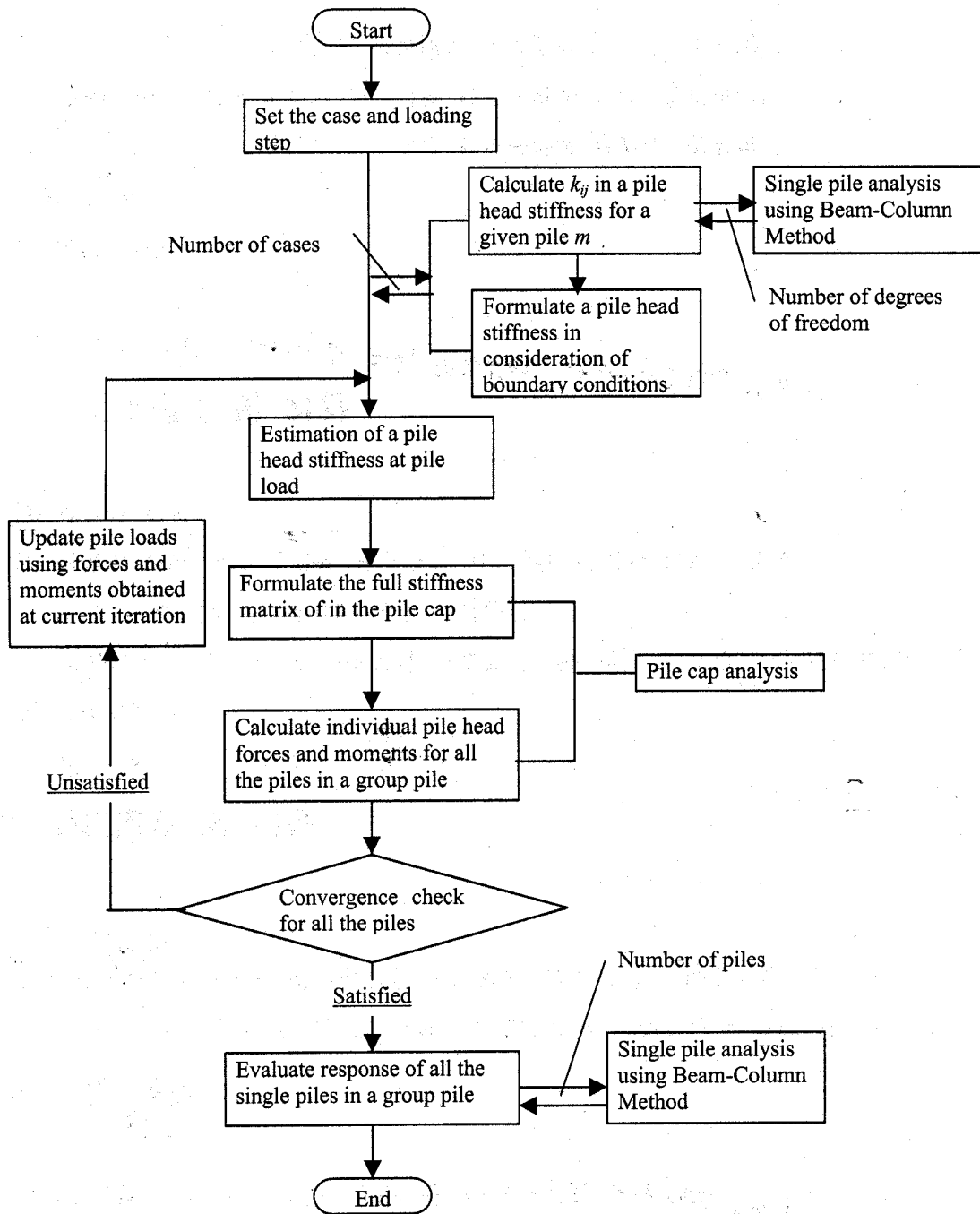
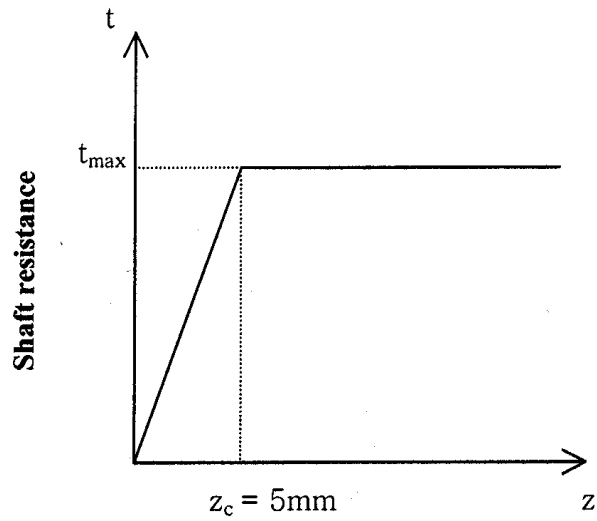
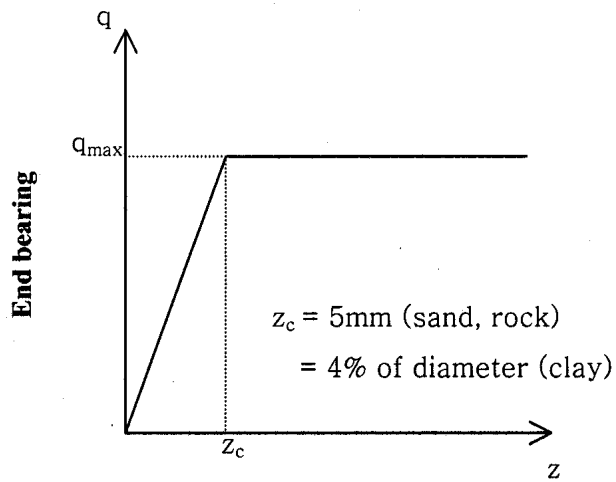

Fig. 2 - Algorithm of three-dimensional group pile analysis



Axial displacement

(a)



Axial displacement

(b)

Fig. 3 - Load transfer curves of axially loaded pile; a) t - z curve, b) q - z curve

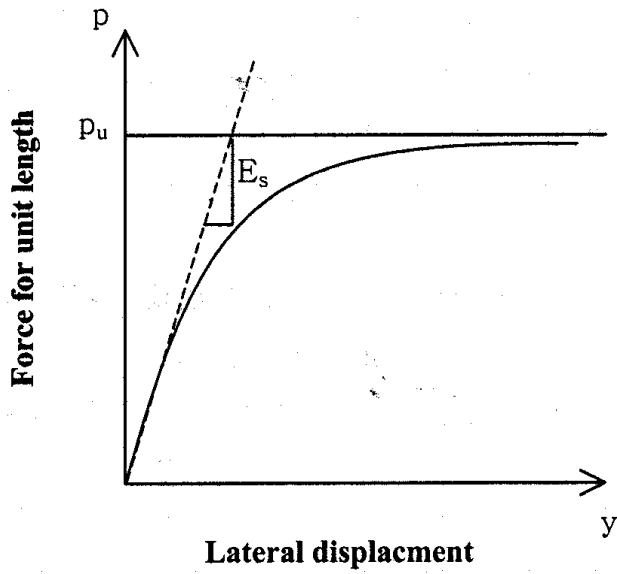

Fig. 4 - Load transfer curves of laterally loaded pile (p - y curve)

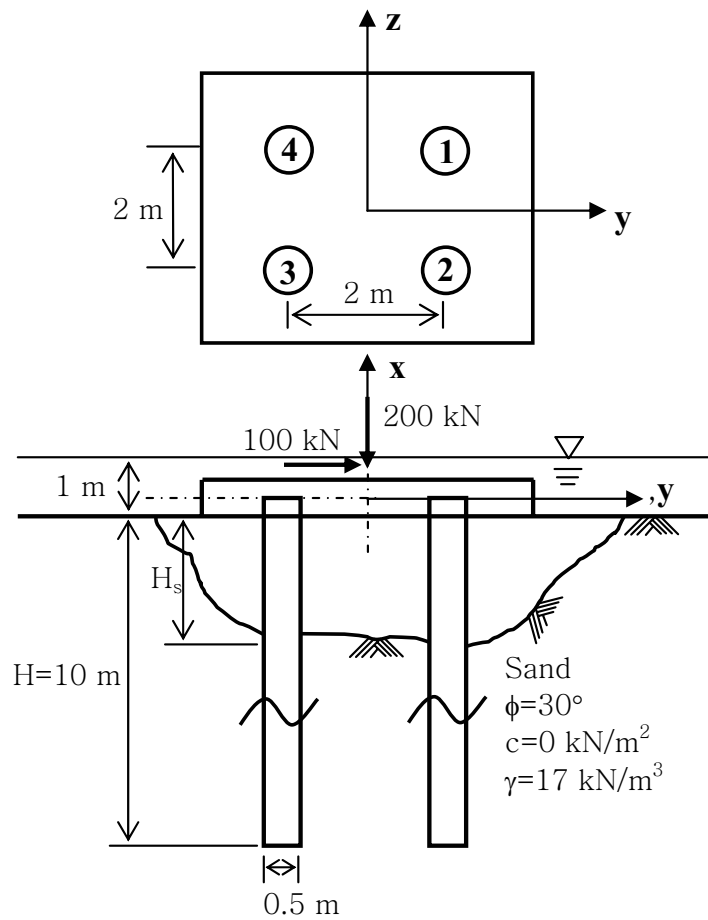

Fig. 5 - A group pile configuration with scouring

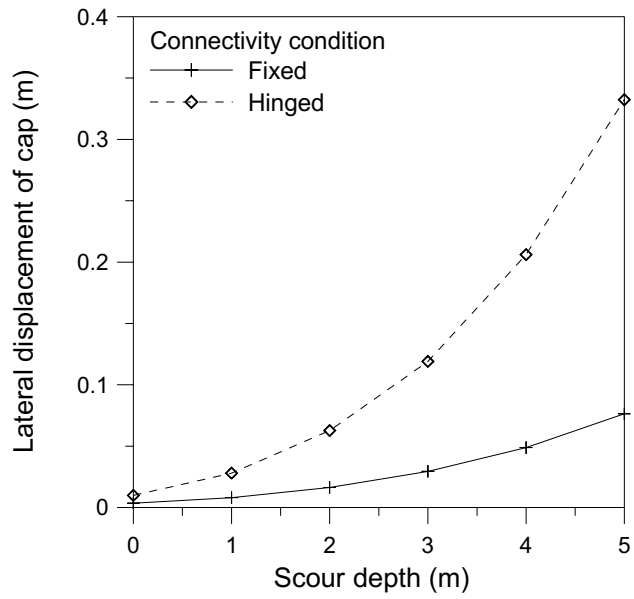

Fig. 6 – Lateral pile cap displacement vs. scour depth

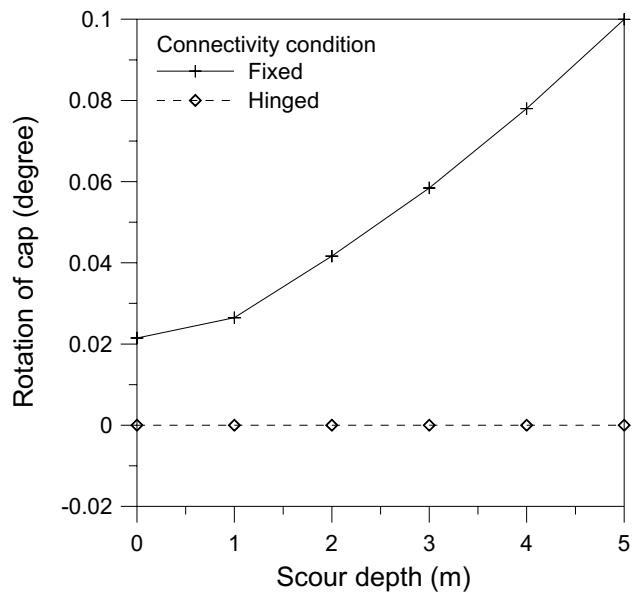

Fig. 7 – Rotation of pile cap vs. scour depth

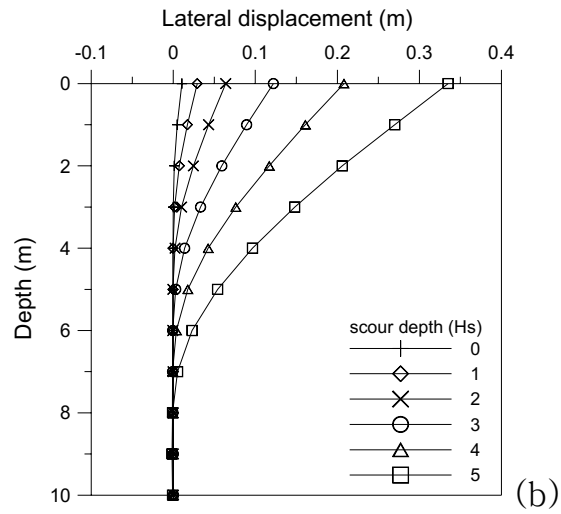
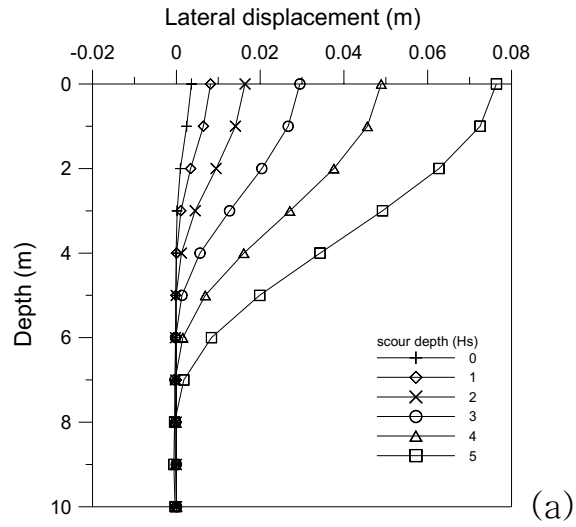
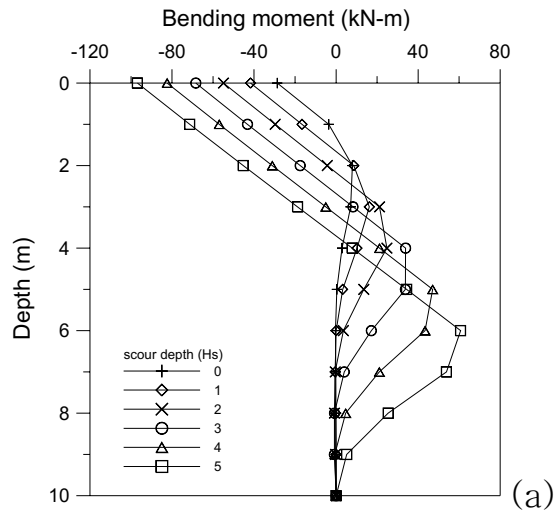

Fig. 8 – Displacement profiles for different scour depths (no. ① pile);
a) fixed head condition, b) hinged head condition



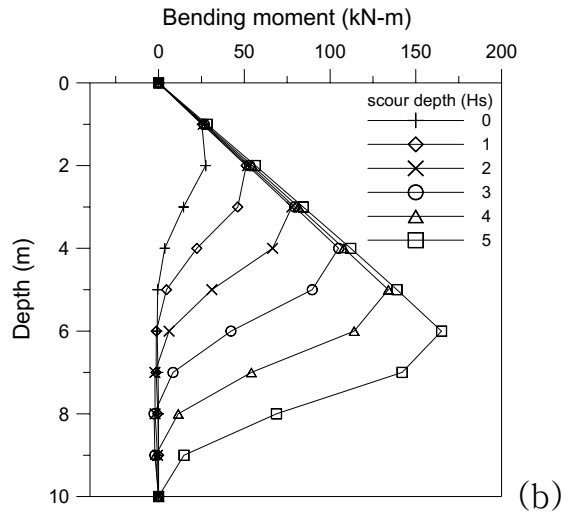

Fig. 9 – Bending moment profiles for different scour depths (no. ① pile); a) fixed head condition, b) hinged head condition

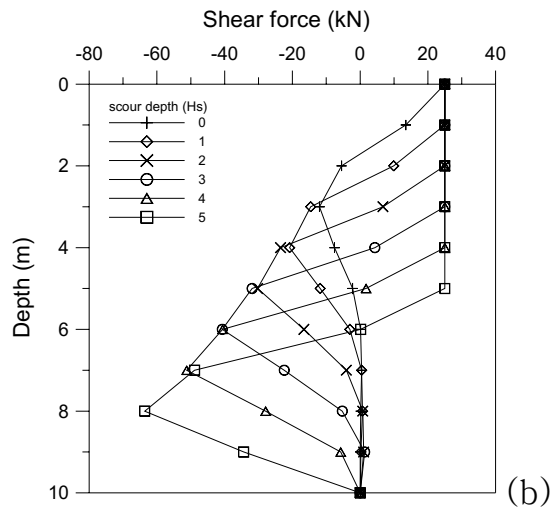
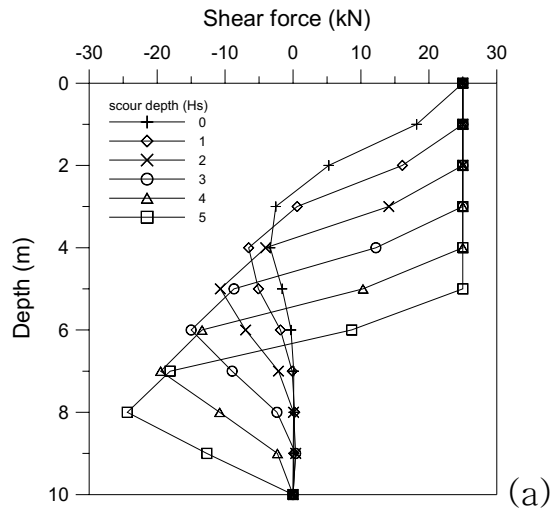

Fig. 10 – Shear force profiles for different scour depths (no. ① pile); a) fixed head condition, b) hinged head condition

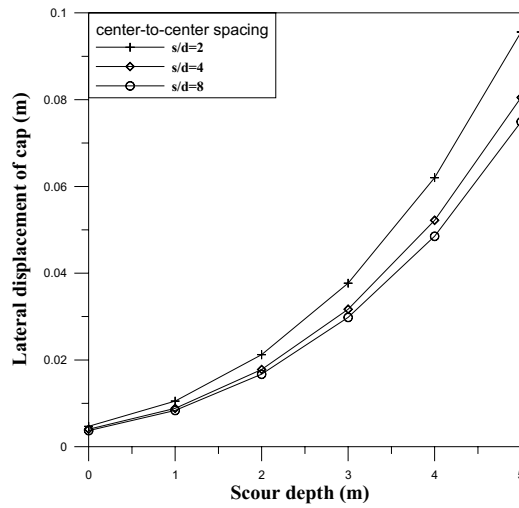

Fig. 11. Effect of pile spacing on pile cap deflection (fixed head condition)

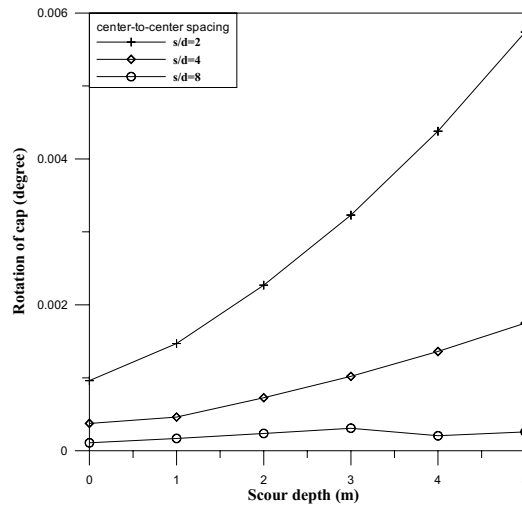

Fig. 12. Effect of pile spacing on pile cap rotation (fixed head condition)

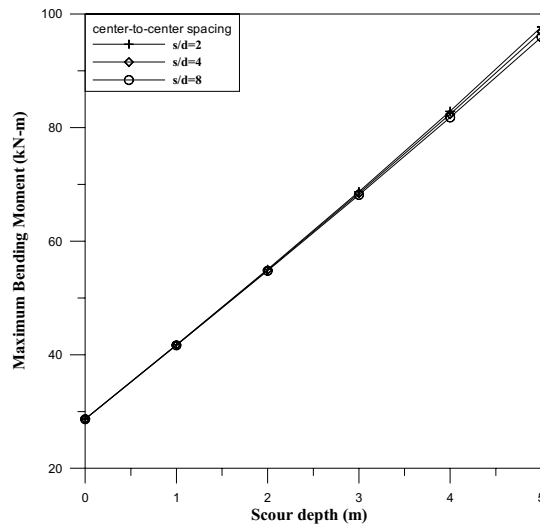

Fig. 13. Effect of pile spacing on maximum bending moment (fixed head)

Table 1. Material properties for pile groups

Pile	Diameter	0.5 m
	Length	10 m
	Elastic modulus	4,000,000 kN/ m ²
Soil	Friction angle	30 degree
	Cohesion	0 kN/m ²
	Unit weight	17.0 kN/m ³
Connectivity condition	Fixed, Hinged	
Loading	Axial	200 kN
	Lateral	100 kN
Scour depth	0, 1, 2, 3, 4, 5 m	

Table 2. Ultimate bearing capacity of pile groups (2×2 arrangement)

Scour depth (m)	Single pile			Group pile
	Skin friction (kN)	Point resistance (kN)	Ultimate bearing capacity (kN)	Ultimate bearing capacity (kN)
0	315.14	171.81	486.95	1947.80
1	273.13	171.81	444.94	1779.76
2	231.11	171.81	402.92	1611.68
3	189.09	171.81	360.90	1443.60
4	147.07	171.81	318.88	1275.52
5	105.05	171.81	276.86	1107.44